



TIMBERPLAY SWING - 4 BAY - MEGA 2VR - STD 2VR

SWTP4MS01



Age groups appropriate for:

 Toddlers & Pre-Schoolers

 Primary to Big Kids

 Teenagers to Young Adults

 Whole family / Young at Heart

SWTP4MS01

FALL ZONE

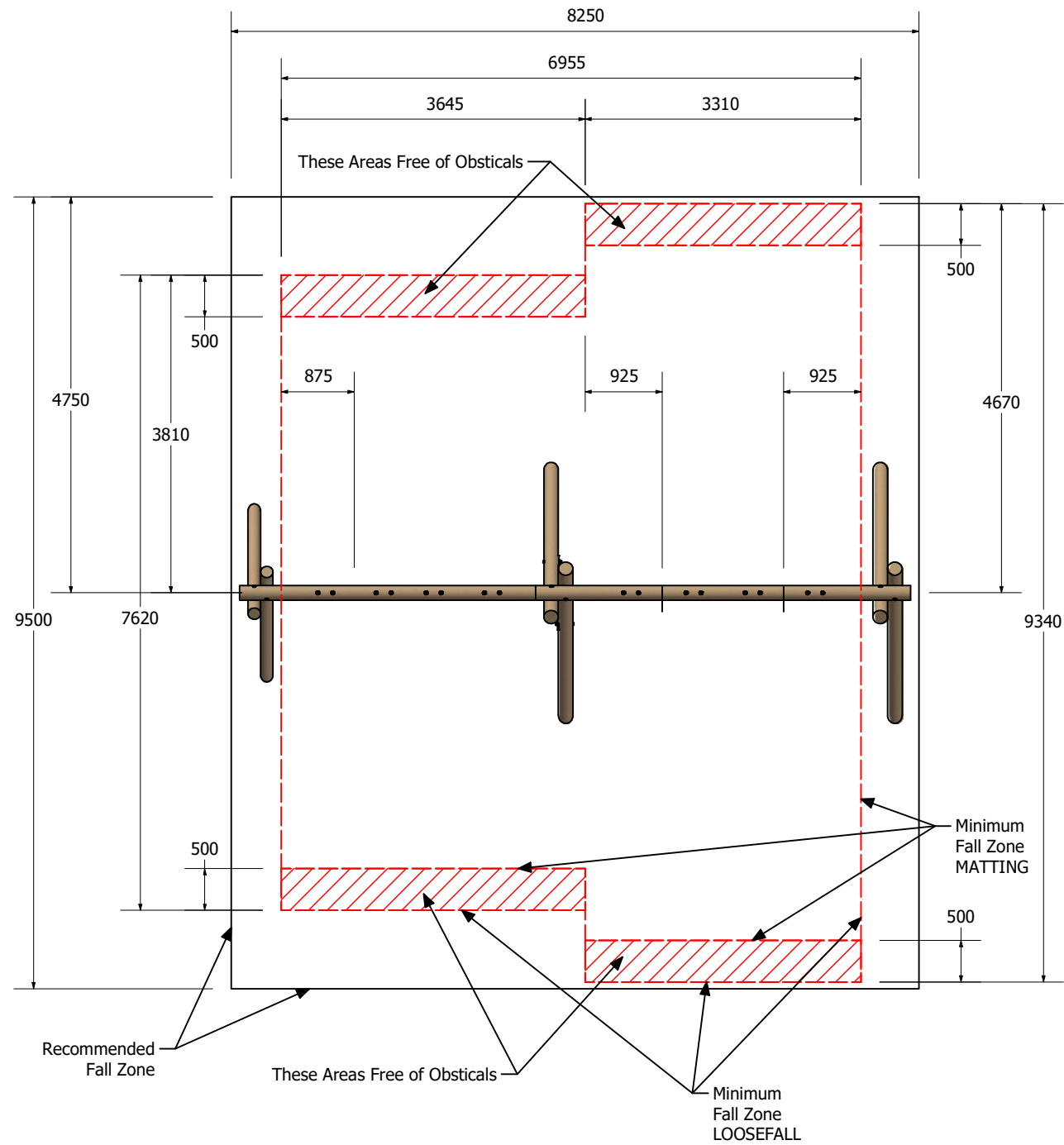

DIMENSIONS AT GROUND LEVEL

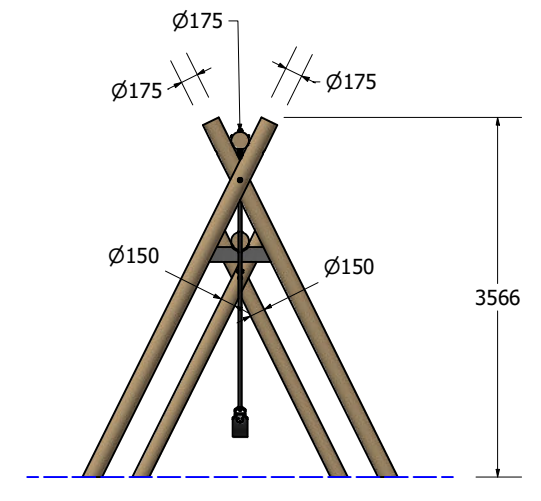
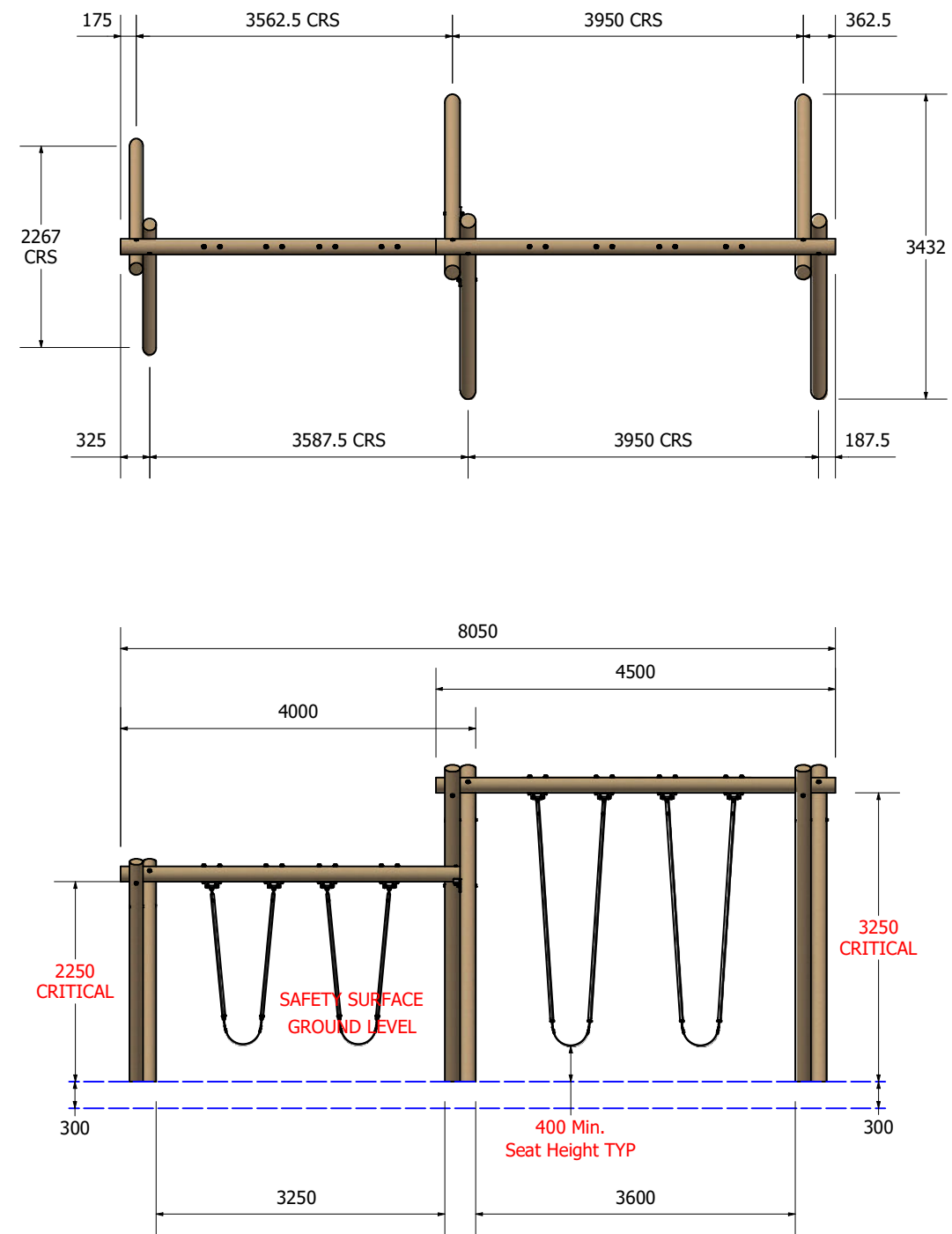

Technical Information	
Main Dimension	9.5m x 8.25m
Total Area	78 sqm
Max FHO	1.8 m
Heaviest Part	100 kg
Compliant to	NZS 5828:2015 AS 4685:(series) EN 1176:2008